

Data Sheet



Article number: 021816011220

Description: Clamp with bracket and rubber
SPGU 6011. 220/30 SK

Measures

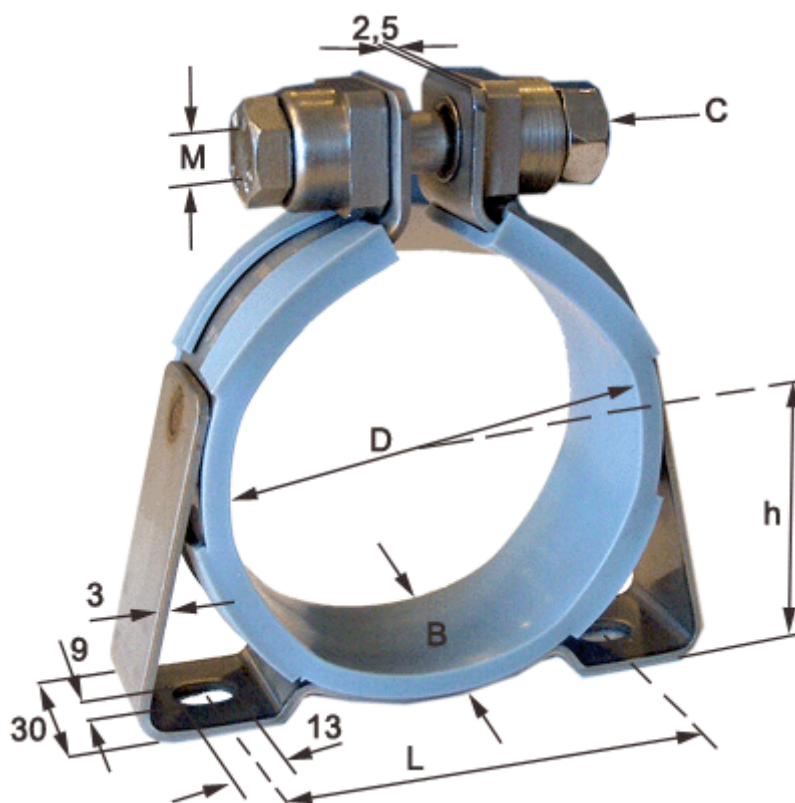

C (screw type) = SK hexagon screw

Diameter D = 220

h = 118

L = 216

Width B = 30